

EPSON

Laser Printer

EPSON EPL-N2750

Quick Reference

4012104-00
XXX

This *Quick Reference* contains information on clearing paper jams, understanding printer error messages, and changing the imaging cartridge.

As a convenient place to keep this guide, attach the included storage box to the side of your printer as shown below.

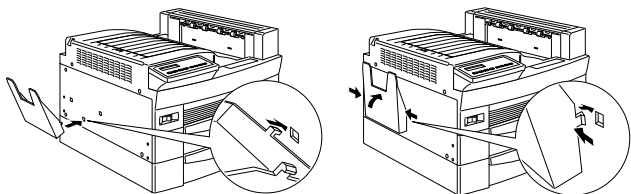

If the 10-Bin Multi-Purpose Unit is installed, attach the guide storage box to the back of the printer as shown below.

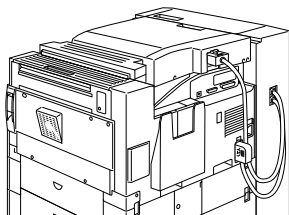

For more details on the items in this guide and about your printer in general, see the *Reference Guide* or *Online Guide*.

Preventing Paper Feed and Paper Jam Problems

To prevent frequent paper feed or paper jam problems, use this checklist of corrective measures.

- Use a high quality paper that is not too thin or too rough.
- Fan the stack of paper and tap its edges to align it before loading.
- Be sure that you do not load too much paper into the paper cassettes.
- Be sure to adjust the paper guides so that paper can slide in and out freely.
- Never let more than 500 sheets accumulate in the output tray on top of the printer.
- Try turning over the stack of paper in the tray. Most paper packages indicate the top side of the paper with an arrow at the side of the package.

Clearing paper jams

When a paper jam occurs, a Jam xxxx xxxx xxxx xxxx message appears on the LCD panel. Xxx indicates areas where jams may be occurring, such as LC1 (standard lower cassette) or A (cover A). See the messages in this section for instructions on clearing paper jams.

Note:

- ❑ Check for jams at all paper sources or paths indicated on the LCD panel. The printer cannot resume printing until all the jams are cleared.
- ❑ The LCD panel displays up to four paper sources or paths at the same time. Other areas where jams may be occurring will be shown on the LCD panel after you have checked all indicated jams.

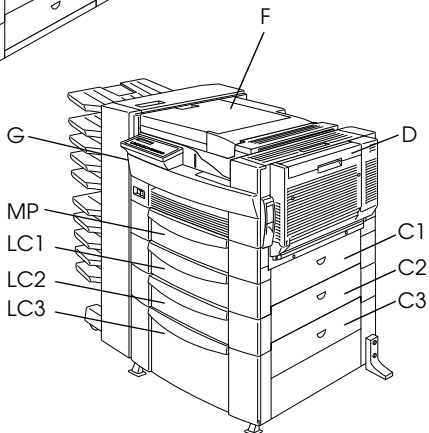
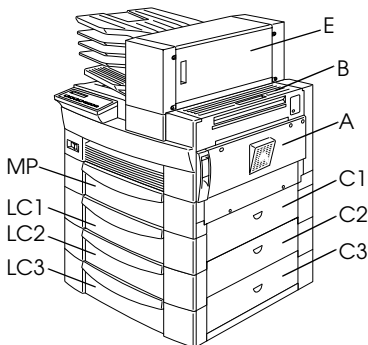

These messages indicate that paper has jammed in one of the optional lower cassettes. The standard lower cassette, located directly beneath the MP tray, is always numbered LC1, and any optional 500-Sheet Lower Cassette Units and the Large Capacity Paper Unit are numbered LC2, LC3, and so on from top to bottom.

Follow these steps to clear paper jammed in the optional lower cassettes:

1. Pull out the cassette indicated on the LCD panel.
2. Carefully remove any paper you find jammed inside the cassette or printer.
3. Remove the stack of paper from the cassette. Even its edges by tapping the paper on a flat surface. Then reinsert the stack into the cassette, making sure the paper is evenly aligned and rests below the maximum paper mark.

Make sure you are using the correct paper size and that your paper meets the specifications for this printer.

4. Push in the cassette.
5. Clear other paper jams that are indicated on the LCD panel, until all error messages disappear.

When the paper jam is cleared completely, the jammed page's print data is automatically reprinted.

This message indicates that there may be a paper jam inside cover A or cover B on the right side of the printer.

Follow these steps to clear paper jammed inside cover A or B:

1. Open cover A gently.

Note:

Because the toner on the paper inside the printer may not have been fixed on the page, toner may come off on your hands when you remove the paper. If you spill toner on your clothing, rinse it off with cold water. Using hot water may leave a permanent stain.



Warning:

When opening the printer, do not touch the hot areas indicated by caution labels inside cover A.

CAUTION
Hot Surface
Avoid Contact

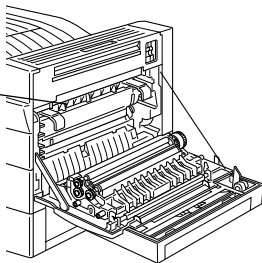

2. Remove any paper you find jammed inside the printer.

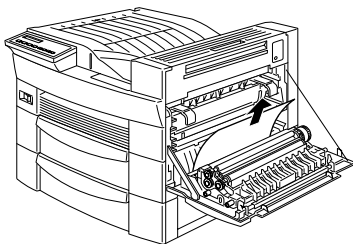

3. If you do not see any paper inside cover A, open cover B.
4. Remove the paper inside cover B. If the paper is difficult to remove, use the gear lever inside cover B as shown below. Push the lever up and down to feed the jammed paper back out through cover B.

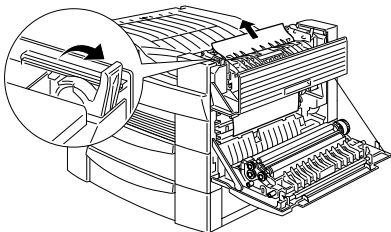

5. Close covers B and A.

When the paper jam is cleared completely, the jammed page's print data is automatically reprinted.

This message indicates that there may be a paper jammed inside cover C1, C2, or C3 on the right side of the lower cassettes.

Follow these steps to clear paper jammed inside the right covers of the lower cassettes:

1. Open the cover indicated on the LCD panel. The names of the cassettes are indicated on each cassette.

Note:

Because the toner on the paper inside the printer may not have been fixed on the page, toner may come off on your hands when you remove the paper. If you spill toner on your clothing, rinse it off with cold water. Using hot water may leave a permanent stain.

2. Remove the paper inside the cover.

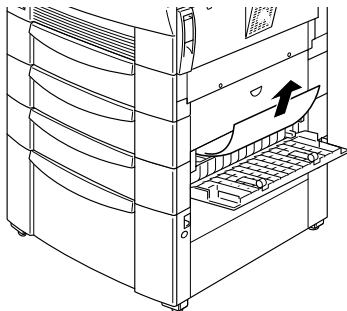

Note:

If the paper jam is in the Large Capacity Paper Unit, you may find it easier to remove the jammed paper if you open both the cover and the cassette.

When the paper jam is cleared completely, the jammed page's print data is automatically reprinted.

Jam D

This message indicates that there may be a paper jam inside the cover of the Duplex Unit, which is also known as cover D.

Follow these steps to clear paper jammed inside the cover of the Duplex Unit:

1. Open cover D.

Note:

Because the toner on the paper inside the printer may not have been fixed on the page, toner may come off on your hands when you remove the paper. If you spill toner on your clothing, rinse it off with cold water. Using hot water may leave a permanent stain.

2. Remove the paper inside the cover.

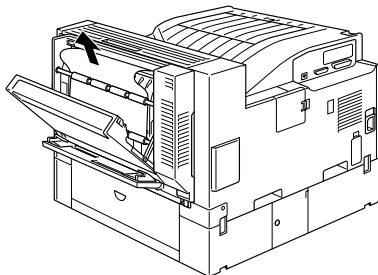

When the paper jam is cleared completely and the cover closed, the jammed page's print data is automatically reprinted.

Jan E

This message indicates that there may be a paper jam inside cover E on the back of the 5-Bin Multi-Purpose Unit.

Follow these steps to clear paper jammed inside the cover of the 5-Bin Multi-Purpose Unit:

1. Open cover E.

Note:

Because the toner on the paper inside the printer may not have been fixed on the page, toner may come off on your hands when you remove the paper. If you spill toner on your clothing, rinse it off with cold water. Using hot water may leave a permanent stain.

2. Remove the paper inside the cover.

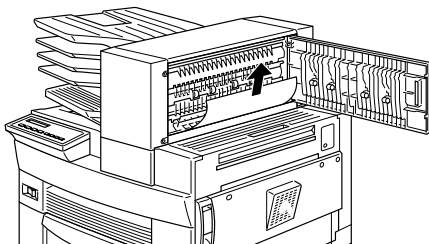

When the paper jam is cleared completely and the cover closed, the jammed page's print data is automatically reprinted.

Jam F

This message indicates that there may be a paper jam inside cover F on the paper guide of the 10-Bin Multi-Purpose Unit.

Follow these steps to clear paper jammed inside the 10-Bin Multi-Purpose Unit's paper guide:

1. Open cover F.

Note:

Because the toner on the paper inside the printer may not have been fixed on the page, toner may come off on your hands when you remove the paper. If you spill toner on your clothing, rinse it off with cold water. Using hot water may leave a permanent stain.

2. Remove the paper inside the cover.

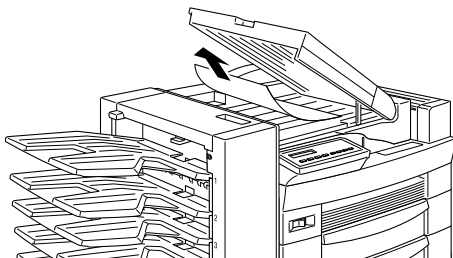

When the paper jam is cleared completely and the cover closed, the jammed page's print data is automatically reprinted.

Jam G

This message indicates that there may be a paper jam inside the upper or lower portion of cover G on the back of the 10-Bin Multi-Purpose Unit.

Follow these steps to clear paper jammed at the back of the 10-Bin Multi-Purpose Unit:

1. Move the 10-Bin Multi-Purpose Unit away from the printer.
2. Open cover G on the back of the 10-Bin Multi-Purpose Unit.

Note:

Because the toner on the paper inside the printer may not have been fixed on the page, toner may come off on your hands when you remove the paper. If you spill toner on your clothing, rinse it off with cold water. Using hot water may leave a permanent stain.

3. Remove the paper inside the cover.
4. Close cover G and reattach the 10-Bin Multi-Purpose Unit to the printer.

When the paper jam is cleared completely, the jammed page's print data is automatically reprinted.

Status and Error Messages

This section contains an alphabetical list of status, error, and warning messages that appear on the LCD panel.

Can't Print Duplex

In your printer driver, select the Duplex Print Unit check box in the Optional Settings dialog box, then select the Duplex check box in the Layout tab. Press the Continue button on the control panel to clear the message. If this doesn't solve the problem, one of the conditions below has occurred and needs to be fixed.

- Paper Size is incorrectly set to CTM, MON, C10, DL, C5 or C6; set this option to a supported paper size.
- Paper Type is set to something other than Plain; set this to Plain.
- The Duplex Unit is not installed properly; reinstall the Duplex Unit.

To clear the error message, (1) press Continue or (2) reset the printer by pressing the ALT and Reset buttons at the same time.

Check Duplex-P Size

This message appears when the paper you loaded differs from the paper size selected in the printer driver's Basic Settings tab or SelecType. Load the correct paper size, or change the paper size setting, then open the Duplex Unit cover and remove any jammed paper. Close the cover of the Duplex Unit, and the printer resumes printing.

Check Paper Size

The Paper Size setting in the printer driver's Basic Settings tab, or in SelecType, is different from the size of paper loaded in the printer. Make sure the correct size of paper is loaded in the printer; then press the Continue button to clear the message.

Check Paper Type

The Paper Type setting in the printer driver's Basic Settings tab, or in SelecType, is different from the type of paper loaded in the printer. Make sure the correct type of paper is loaded in the printer; then press the Continue button to clear the message.

Collate was disabled

The printer does not have sufficient memory to collate print jobs. Only one set of copies will be printed. Reduce the contents of your print jobs or add more memory to the printer.

Press the Continue button to clear the message.

Cover A Open

Cover A, on the right side of the MP tray, is open. Pull up the latch on cover A, then close the cover firmly.



Warning:

Do not touch the hot areas indicated on the caution labels inside cover A.

If you still cannot close the cover, the imaging cartridge may not be installed correctly. Reinstall the imaging cartridge as described in “Replacing the Imaging Cartridge” on page 26.

Cover C1, C2, C3 Open

The cover on the right side of the standard lower cassette, an optional 500-Sheet Lower Cassette Unit, or the Large Capacity Paper Unit is open. Pull the latch on the cover indicated by the message and then close the cover firmly. (The numbers indicate the order in which the cassettes are stacked from top to bottom).

Cover D Open

Cover D, on the back of the Duplex Unit, is open. Pull the latch on cover D and then close the cover firmly.

Cover E Open

Cover E, on the back of the 5-Bin Multi-Purpose Unit, is open. Pull the latch on cover E and then close the cover firmly.

Cover F Open

Cover F, on the paper guide of the 10-Bin Multi-Purpose Unit, is open. Pull the latch on cover F and then close the cover firmly.

Cover G Open

Cover G, on the back of the 10-Bin Multi-Purpose Unit, is open. Move the 10-Bin Multi-Purpose Unit away from the printer, then pull the latch on cover G and close the cover firmly.

Duplex Mem Overflow

There is not enough memory for duplex printing. The printer prints only on the top side and ejects the paper. To correct this error, follow the directions below.

If `Auto Cont` is set to `Off` in the `SelectType Config Menu`, (1) press the `Continue` button or (2) reset the printer by pressing the `ALT` and `Reset` buttons at the same time.

If `Auto Cont` is set to `On` in the `SelectType Config Menu`, the error is corrected automatically.

Face-down Full

The face-down tray is full of printed sheets. Remove the sheets from the face-down tray and press `Continue`.

Format Error ROM A

A ROM module which is not formatted is installed in slot A. If the ROM had been written to, it is possible that the writing was not completed. Also, the ROM's memory may no longer be accessible, in which case you should replace it.

To correct this error, (1) press the Continue button, or (2) turn off the printer, then remove the ROM module from slot A.

Format Error ROM B

A ROM module which is not formatted is installed in slot B. If the ROM had been written to, it is possible that the writing was not completed. Also, the ROM's memory may no longer be accessible, in which case you should replace it.

To correct this error, (1) press the Continue button, or (2) turn off the printer, then remove the ROM module from slot B.

Form Feed

When the printer is offline and data remains in the printer's memory, press the Form Feed button to print out the data and clear the buffer. After printing, Ready appears on the LCD panel.

HDD CHECK

The printer is checking the optional Hard Disk Drive.

Image Optimum

The printer cannot print at the requested quality level because of insufficient memory, and the printer reduces the quality automatically so that it can continue printing. Check to see if the printout is acceptable. If not, add more memory (for a permanent solution) or temporarily set the Print Quality setting to LOW in the printer driver.

Insert Imaging Crtg

The imaging cartridge is not correctly installed. See “Replacing the Imaging Cartridge” on page 26 to reinstall it.

Invalid AUX I/F Card

An interface card not supported by this printer is installed. Turn off the printer, then remove the card.

Invalid HDD

A hard disk drive that cannot be used with this printer is installed. Turn off the printer and remove the drive.

Invalid Option

An option not supported by this printer is installed, or a supported option is installed incorrectly. See “Using Options” in the *Reference Guide* to make sure you are using options made for this printer or to reinstall the options.

Invalid PS3

A PostScript 3 ROM module not supported by this printer is installed, or a supported module is installed incorrectly. Make sure you are using the correct PostScript 3 ROM module. If you are, try reinstalling the module.

Invalid ROM A

The ROM module in slot A is not supported by this printer, or a supported module is installed incorrectly. Make sure you are using a suitable ROM module for this printer. If you are, try reinstalling the module.

Invalid ROM B

The ROM module in slot B is not supported by this printer, or a supported module is installed incorrectly. Make sure you are using a suitable ROM module for this printer. If you are, try reinstalling the module.

Jam xxx xxx xxx xxx

Paper is jammed in the tray, cassettes, covers, or other devices indicated by xxx. Remove the jammed paper. See "Clearing paper jams" on page 1 for help with clearing the jam. See "Preventing Paper Feed and Paper Jam Problems" on page 1 for advice on preventing this problem.

Job Cancel

The print job sent to your printer is canceled.

Manual Feed xxx yyy

Manual feed mode is specified for the current print job. Make sure the indicated paper size (xxx) is loaded in the indicated paper source (yyy), then press the On Line button. The printer feeds paper according to the Paper Source setting.

If you do not want to print this job in the manual feed mode, press Continue.

Mem Overflow

The printer has insufficient memory available for the current task. To correct this error, do one of the following: 1) press the Continue button, or 2) reset the printer by pressing the ALT and Reset buttons at the same time.

You can also clear this error by turning the printer off and back on again. However, it may be necessary to reduce the number or size of fonts, reduce the number or size of graphics, lower the resolution, or add more memory to the printer.

Menus Locked

SelectType, which is usually accessible from the printer's control panel, has been disabled. This setting can be cleared by using the EPSON WebAssist utility. Clear the Panel Lock setting in the Configuration-Printer-Print-Setup Menu.

Multibin <N> Full

The bin indicated by <N> (1 to 10) on an optional multibin unit is full. Remove the sheets from the bin and press Continue.

Multibin is Removed

The 10-Bin Multi-Purpose Unit is not installed properly, or is not firmly attached to the printer. Install the unit as instructed in "Installing the 10-Bin Multi-Purpose Unit" in the *Reference Guide*, then press Continue.

Need Memory

Your printer lacks the printer memory required to print your print job. Reduce the amount of images or text in the print job, or install an optional memory module. See "Memory Modules" in the *Reference Guide*.

Offline

The printer is not ready to print.

Outbin Select Error

The printer cannot feed paper to the output tray you selected, because of a paper size discrepancy. The printed sheet is fed to the Face-down Tray (or Bin 1) of the Multi-Purpose Unit.

Press the Continue button to clear this message. Select Face-down Tray (Bin 1) as the Output Tray setting in the printer driver. If you want to output to another tray instead of Bin 1, change the Paper Size setting of your document.

Paper Out xxx yyy

There is no paper in the specified paper source (xxx). Load paper of the indicated size (yyy) into the source. See “Basic Printing Operations” in the *Reference Guide* for instructions on loading paper.

Paper Set xxx yyy

The paper loaded in the indicated tray (xxx) does not match the indicated paper size (yyy). Replace the paper with the correct size of paper and press Continue.

Print Overrun

The time required to process data exceeds the print engine speed because the volume of data is too great. Press Continue to resume printing. If this message appears again, change the Page Protect setting in the SelectType Config Menu.

PS3 Hard Disk Full

The writing of PostScript 3 commands on the optional Hard Disk Drive is no longer possible as the amount of space allocated to PostScript 3 on the Hard Disk Drive is used up.

Ready

The printer is ready to receive data and print.

Remove Output Paper

This message appears when the Multibin Mode setting has been changed and paper remains in an optional multibin unit. Remove all the paper in the multibin unit.

Reset

The printer's current interface has been reset and the buffer is cleared. However, other interfaces are still active and retain their settings and data.

Reset All

All printer settings have been reset to the user default configuration, or to the last settings that were saved.

Reset to Save

You have changed the SelecType setting but the new setting was not activated immediately after exiting SelecType. To activate the new setting, do one of the following: 1) exit SelecType by pressing Continue or On Line (the new setting is activated after the current print job is finished), or 2) reset the printer by pressing the ALT and Reset buttons at the same time.

ROM CHECK

The printer is checking the ROM.

RAM CHECK

The printer is checking the RAM.

Self Test

The printer is performing a quick internal check.

Service Req xxxxx

A controller error or a print engine error has been detected. Write down the error number listed on the LCD panel (xxxxx) and turn off the printer. Wait at least five seconds and then turn it back on. If the error message still appears, turn off the printer, unplug the power cord, and contact a qualified service representative.

Standby

The printer is in its low power state; however, it is still online if the On Line light is on.

Toner Low

The printer is almost out of toner. Prepare a new imaging cartridge to replace the current one.

Toner Out

You must replace the imaging cartridge. See "Replacing the Imaging Cartridge" on page 26.

Press Continue to print one more page.

Warning Up

The printer is warming up. When the printer is ready, this message will change to Ready.

Write Error ROM A

There is no ROM module installed in slot A, or the installed module cannot be written to. It is also possible that writing to the ROM in slot A began, but was not completed.

To correct this error, do one of the following: 1) turn off the printer and remove the ROM, then turn on the printer, 2) reset the printer by pressing the ALT and Reset buttons at the same time.

Write Error ROM P

The program ROM cannot be written to. It is also possible that writing to the ROM was not completed.

To correct this error, do one of the following: 1) turn off the printer, then turn it on again, 2) press the Continue button, or 3) reset the printer by pressing the ALT and Reset buttons at the same time.

Writing ROM A

The printer is writing data into the ROM module in slot A.

Writing ROM P

The printer is writing data onto the program ROM.

Replacing the Imaging Cartridge

The imaging cartridge prints up to 15,000 pages depending upon the complexity of your print jobs.

If your printed images become faint, enter the SelecType Setup Menu and use the Toner function to find out approximately how much toner remains in the imaging cartridge. For instructions, see “SelecType Settings” in your *Reference Guide*.

Once the toner level is displayed on the LCD panel, simply count the asterisks between the E (empty) and the F (full). Each asterisk represents about 25% of the total toner capacity. If you see only one asterisk on the LCD panel, prepare a replacement imaging cartridge.

Replace the cartridge with the S051068 imaging cartridge even if the cartridge you remove has a different part number. The S051068 cartridge is specially designed for your high-quality 600-dpi printer.

Follow these steps to replace the imaging cartridge:

1. Make sure the printer is turned on.
2. Open the printer cover A.



Warning:

When opening the printer, do not touch the hot areas indicated by the caution labels inside cover A.

CAUTION
Hot Surface
Avoid Contact

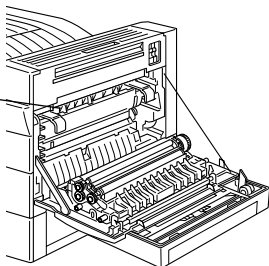

3. Remove the imaging cartridge by pulling the handles on the front of the cartridge toward you.

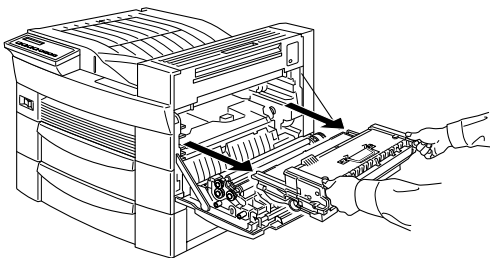

4. Dispose of the used imaging cartridge as a nonburnable item.



Warning:

Do not dispose of used imaging cartridges in fire, as they can explode and cause injury. Dispose of them according to local regulations.

5. While holding the new imaging cartridge horizontally, gently shake it a few times to distribute the toner evenly.

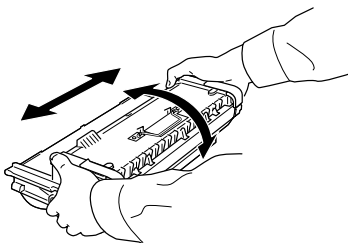

Caution:

- Do not turn the imaging cartridge upside down.
- Do not expose the imaging cartridge to room light any longer than necessary. Overexposing the cartridge may cause abnormally dark or light areas to appear on the printed page and reduce the life of the cartridge.

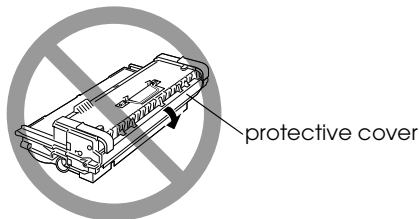

- To release the spring-loaded carrying handles on the sides of the new cartridge, hold down each handle with your hand and remove the tape, then take your hand away slowly.



Warning:

When you remove the tape, the handle may spring up quickly enough to hurt your fingers. To avoid this, hold the handle firmly while peeling off the tape.

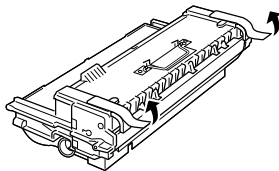

- Pick up the imaging cartridge by the carrying handles and insert the cartridge all the way into the printer.

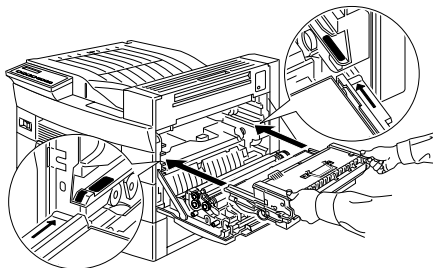

8. Close cover A by pushing it up and into the printer.

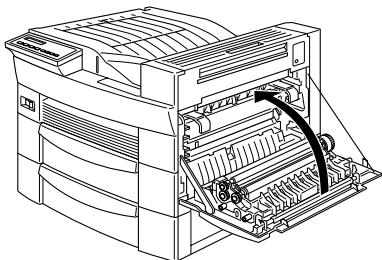

Caution:

Never transport the printer with the imaging cartridge installed.

EPSON

Laser Printer

EPSON EPL-N2750

Quick Reference

Printed in Japan
00.XX-XX