

EPSON

All in One Product

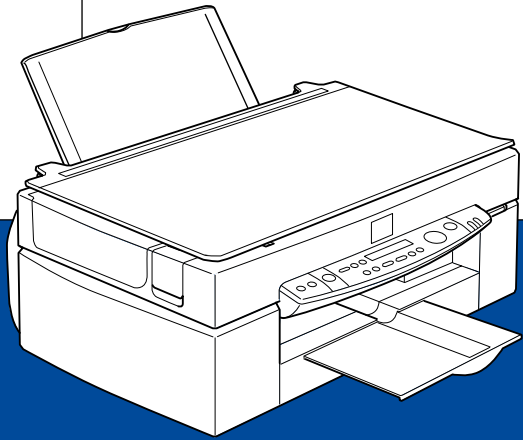

EPSON STYLUS™ SCAN 2500

Setup Guide

4010665
XXX-00

Contents

Releasing the Transportation Lock	1
Attaching the Paper Support	2
Plugging in the Stylus Scan	3
Connecting the Stylus Scan to Your Computer	3
Using the parallel port (for Windows 98 and 95)	4
Using the USB port (for Windows 98 and Macintosh)	4
Installing the Drivers and Other Software in Your PC	5
For Windows 98 or 95 with a parallel connection	6
For Windows 98 with a USB connection	11
Installing the software in your Macintosh	20
Installing Ink Cartridges	27
Checking the Stylus Scan	31
Loading paper	31
Printing a nozzle check pattern	33
Cleaning the print head	34
After Setup	35
Changing the connection port (for Windows 98)	35
Uninstalling the USB driver	35
Uninstalling the parallel driver	36

Releasing the Transportation Lock

Before connecting the Stylus Scan to a power source, you must release the transportation lock. To release the transportation lock, follow the steps below.

1. Open the document cover.

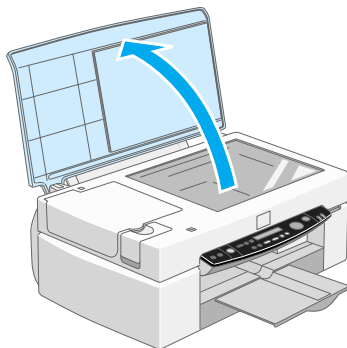

2. Open the maintenance cover.

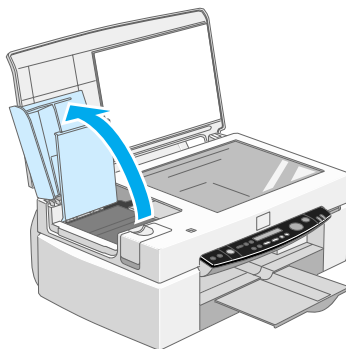

3. Slide the transportation lock, as shown in the illustration below, to release the scanner carriage.

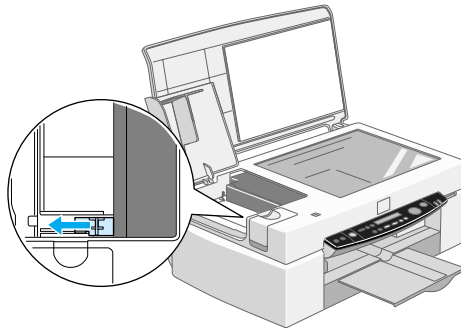

Note:

Be sure to lock the transportation lock again before moving the Stylus Scan.

4. Close the maintenance cover and document cover.

Attaching the Paper Support

Insert the paper support into the slots at the rear of the Stylus Scan.

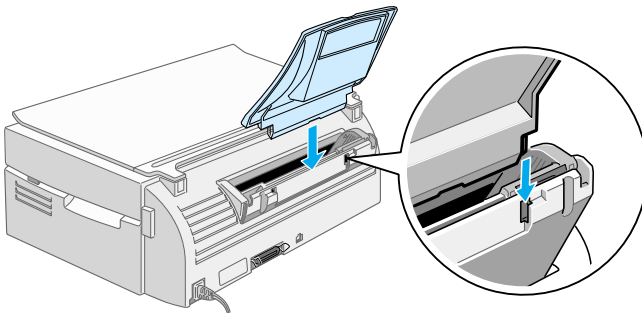

Plugging in the Stylus Scan

1. Make sure that the Stylus Scan is turned off.
2. Check the label on the back of the Stylus Scan to make sure the voltage required by the Stylus Scan matches that of the your electrical outlet. Also, make sure that you have the correct power cable for your power source.



Caution:

It is not possible to change the Stylus Scan's voltage. If the rated voltage and your outlet voltage do not match, contact your dealer for assistance. Do not plug in the power cord.

3. If the power cord is not attached to the Stylus Scan, connect it to the AC inlet at the back of the Stylus Scan.
4. Plug the power cord into a properly grounded electrical outlet.

Connecting the Stylus Scan to Your Computer

Your Stylus Scan has two ports through which it can be connected to a computer; a parallel port and a USB port. Use the port appropriate for your computer.

Note:

- ❑ *If your computer has both a parallel and USB port, be sure to follow the correct steps to connect to the port you choose.*
- ❑ *Do not use the Stylus Scan's parallel port and USB port simultaneously. Connect the Stylus Scan to one computer at a time.*

Using the parallel port (for Windows 98 and 95)

To connect the Stylus Scan to your PC using the parallel port, you need a shielded, twisted-pair parallel cable. Follow the steps below to connect your Stylus Scan to your PC via the parallel port.

1. Make sure both the Stylus Scan and computer are turned off.
2. Plug the cable connector securely into the parallel interface connector at the rear of the Stylus Scan. Squeeze the wire clips together until they lock in place on both sides. If there is a ground wire at the end of the cable, connect it to the ground connector at the back of the Stylus Scan.

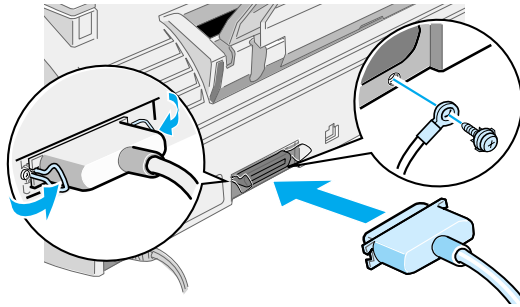

3. Plug the other end of the cable into the computer's parallel interface.

You are now ready to install the Stylus Scan drivers. For installation instructions, see "For Windows 98 or 95 with a parallel connection" on page 6.

Using the USB port (for Windows 98 and Macintosh)

To connect the Stylus Scan to your computer using the USB port, you must first install the Stylus Scan drivers.

To install the drivers and connect the Stylus Scan to a computer running Windows 98 and using the USB port, see "For Windows 98 with a USB connection" on page 11.

To install the software and connect the Stylus Scan to your Macintosh, see "Installing the software in your Macintosh" on page 20.

Installing the Drivers and Other Software in Your PC

Your Stylus Scan comes with the EPSON Stylus Scan 2500 Software for Windows CD-ROM which includes software for your Stylus Scan.

To print and scan with your Stylus Scan, you need to install the following software included on the CD-ROM.

EPSON SMART PANEL

Provides easy access to the Stylus Scan's scanning, printing, and copying features.

EPSON Stylus Scan 2500 Drivers

Printer Driver

Allows you to use the Stylus Scan's printer function.

EPSON Stylus Scan FB TWAIN

EPSON Stylus Scan FB TWAIN controls the Stylus Scan's scanner function.

EPSON Scanner Monitor (except Windows 98 USB)

This software detects when the "Scan Button" is pressed on the Stylus Scan panel. The "Scan Button" automatically starts the software selected in the EPSON Scanner Monitor.

The included CD-ROM also contains the following software.

❑ **Acrobat Reader**

This software enables you to read the manuals for EPSON SMART PANEL and WinFAX, and any other files that are in the Portable Document Format (PDF).

❑ **WinFax BASIC EDITION**

Includes applications that support the Stylus Scan's fax features and other special operations.

For Windows 98 or 95 with a parallel connection

After connecting the Stylus Scan to your computer as described in "Using the parallel port (for Windows 98 and 95)" on page 4, follow the steps below to install the drivers and other software.

Note for users with a parallel connection:

- ❑ *Before installing the software on your computer, make sure there is not a Stylus Scan driver already installed on your computer. If there is, see "Uninstalling the parallel driver" on page 36 and uninstall the software before following the steps below.*
- ❑ *Make sure the ECP mode is turned on in your computer's BIOS. For details, see your computer documentation.*

1. Turn on the computer and start Windows.

Note:

If you turn on the Stylus Scan before turning on your PC, the computer may detect the Stylus Scan and display the New Hardware Found dialog box or a similar wizard, following start-up. If this occurs, click the Cancel button to close the dialog box, and continue with installation as described below.

2. Insert the EPSON Stylus Scan 2500 Software for Windows CD-ROM in the CD-ROM drive. The Select Language dialog box appears.



3. Select the language you want and click OK.
4. Click the Add Software button.



5. The EPSON Software Setup dialog box appears. Make sure there is a check mark next to EPSON SMART PANEL and EPSON Stylus Scan 2500 Drivers. Clear the check marks next to the names of any software that you do not want to install.

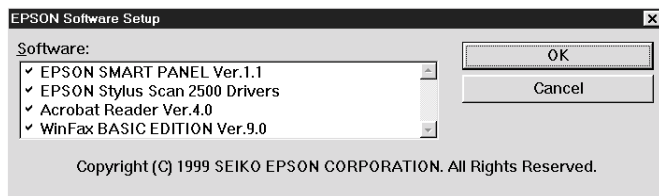

6. Click OK.
7. Follow the on-screen instructions to install EPSON SMART PANEL.
8. When installation is complete, the EPSON Stylus Scan Setup dialog box appears. Click Next.



9. In Windows 98, the following dialog box appears. Select LPT (Printer Port), then click Next to begin installation. (If this dialog box does not appear, go to the next step.)

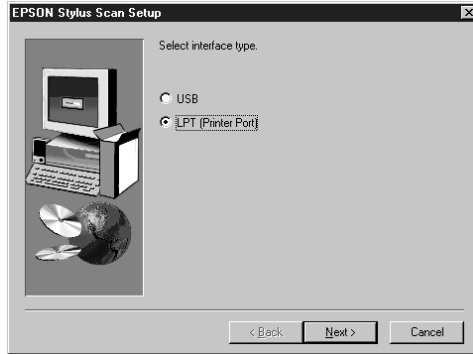

10. When installation is complete, click OK to start the EPSON Screen Calibration utility.



Note:

Be sure to calibrate your screen and Stylus Scan to ensure that the colors of reproduced images closely match the originals.

11. In the following window, move the slider to the right or left until the two shades of gray horizontal stripes match.

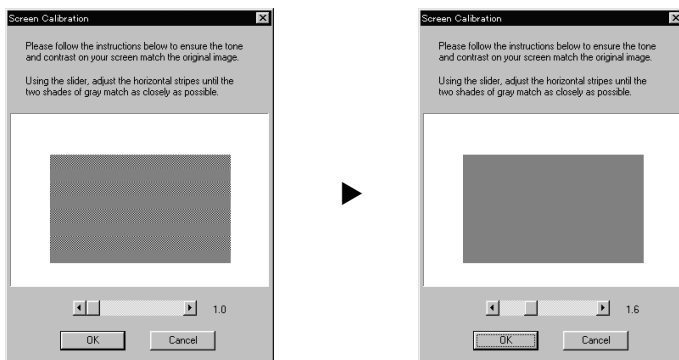

Note:

The gray stripes will not perfectly blend together; however, try to make the two tones match as closely as possible.

12. Click OK to register the calibration setting.
13. When the EPSON Stylus Scan Drivers installation is complete, installation of other applications begins automatically. Follow the on-screen instructions.
14. After all applications have been installed, a message appears asking you to restart your computer. Click OK.
15. Restart the computer, then turn on the Stylus Scan by pressing the  power button.

Note:

Do not change the printer name (leave it as EPSON Stylus Scan 2500), otherwise your Stylus Scan will not work correctly.

For Windows 98 with a USB connection

Before connecting the Stylus Scan to your Windows 98 computer using the USB port, you must first install the Stylus Scan software. This section guides you through the software installation and also includes instructions on connecting the Stylus Scan to your computer using the USB port. Follow the steps below.

Note:

Your computer must be a Windows 98 pre-installed model. You cannot install or run the USB Printer Driver on a computer which is not equipped with a USB port or which is upgraded from Windows 95 to 98.

1. Make sure the Stylus Scan is off, and that it is not connected to your computer. Then turn on the computer and start Windows 98.

Note:

If you turn on the Stylus Scan before turning on your computer, the computer may detect the Stylus Scan and display the New Hardware Found dialog box, or a similar wizard. If this occurs, click the Cancel button to close the dialog box, and remove the USB cable. Then continue with installation as described below.

2. Insert the EPSON Stylus Scan 2500 Software for Windows CD-ROM in the CD-ROM drive. The Select Language dialog box appears.

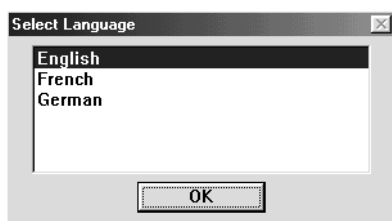

3. Select the language you want and click OK.

4. Click the Add Software button.

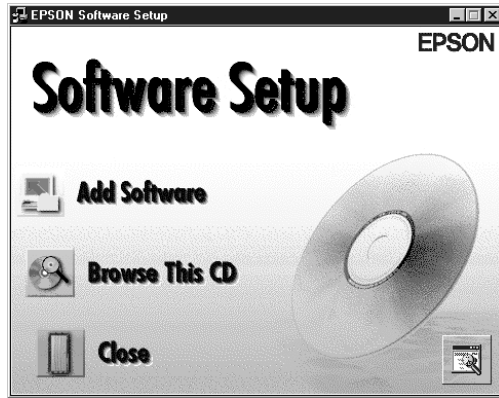

5. The EPSON Software Setup dialog box appears. Make sure there is a check mark next to EPSON SMART PANEL and EPSON Stylus Scan 2500 Drivers. Clear the check marks next to the names of any other software that you do not want to install.

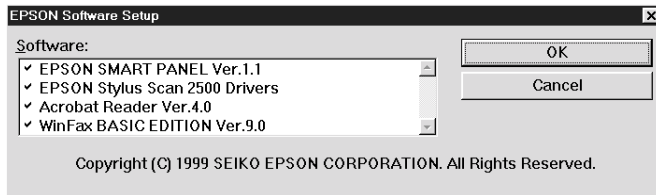

6. Click OK.
7. Follow the on-screen instructions to install EPSON SMART PANEL.

- When installation is complete, the EPSON Stylus Scan Setup dialog box appears. Click Next.



- The following dialog box appears. Select USB, then click Next.

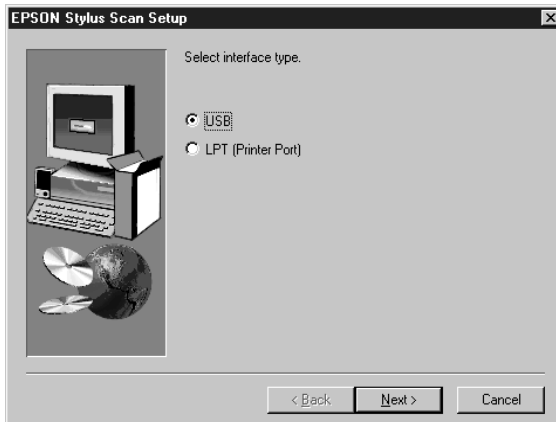



10. The following message appears.

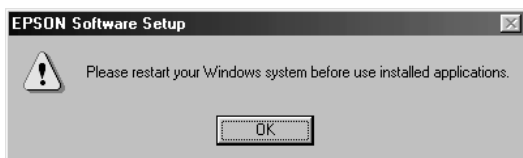

Click OK. Installation for other applications begins automatically. Follow the on-screen instructions.

11. After the applications have been installed, the following message appears.



Click OK and restart your computer. Then turn on the Stylus Scan by pressing the  power button.

12. Plug the appropriate end of the cable into the USB port on the back of the Stylus Scan. (The end that attaches to the Stylus Scan has a different shape from the end that attaches to the computer.)

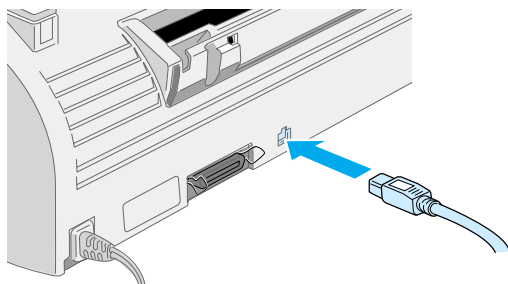

Note:

To connect the Stylus Scan to a USB port, you need a standard shielded USB cable.

13. Connect the other end of the cable to the computer's USB port.

Note:

If you have more than one USB hub connected to your computer, connect the Stylus Scan to the hub that is connected directly to your computer. If the Stylus Scan does not work properly when connected to the hub, connect it directly to the computer's USB port.

14. If the following dialog box appears, click Next. Otherwise skip to step 19.



15. The dialog box shown below appears. Click Next.



16. In the following dialog box, clear all the check boxes, then click Next.



17. In the following dialog box, click Next to install the required drivers.



Note:

If a dialog box appears asking you to specify the location of the Windows 98 CD-ROM, insert the Windows 98 CD-ROM into the CD-ROM drive and click OK.

18. Click Finish to complete the USB Hub driver installation.



19. The following message appears.

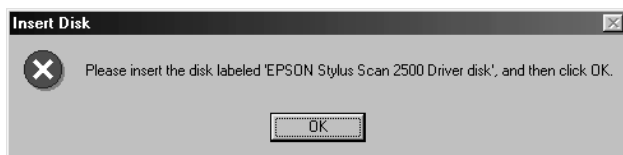

Make sure the EPSON Stylus Scan 2500 Software for Windows CD-ROM is still in your CD-ROM drive, and click OK.

20. The following dialog box appears.

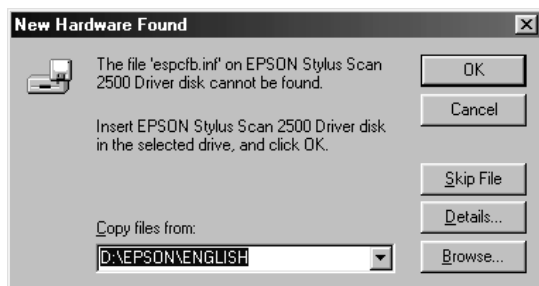

In the Copy files from box, type D:\EPSON\ENGLISH (or your preferred language). Then click OK. Substitute the appropriate drive letter for your CD-ROM drive as necessary. The system installs the required driver.

Note:

Depending on your system, you may have to repeat steps 19 and 20 to install the printer driver and the scanner software.

21. During driver installation, the EPSON Screen Calibration utility starts automatically.

Note:

Be sure to calibrate your screen and Stylus Scan to ensure that the colors of reproduced images closely match the originals.

22. In the following window, move the slider to the right or left until the two gray horizontal stripes match.

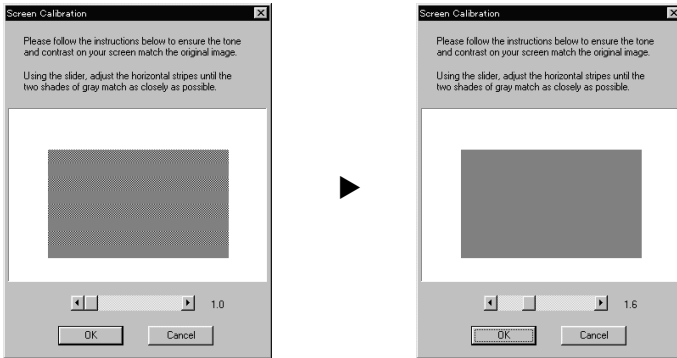

Note:

The gray stripes will not perfectly blend together; however, try to make the two tones match as closely as possible.

23. Click OK to register the calibration setting.
24. Follow the on-screen instructions to complete the installation.

Note:

Do not change the printer name (EPSON Stylus Scan 2500), otherwise your Stylus Scan will not work correctly.

Installing the software in your Macintosh

To print and scan with your Stylus Scan, you need to install the following software included on the EPSON Stylus Scan 2500 Software for Macintosh CD-ROM shipped with your Stylus Scan. This software must be installed before connecting the Stylus Scan to your Macintosh.

❑ EPSON SMART PANEL

Provides easy access to the Stylus Scan's scanning, printing, and copying features.

❑ EPSON Stylus Scan 2500 Drivers

Printer Driver

Allows you to use the Stylus Scan's printer function.

EPSON Stylus Scan FB TWAIN

EPSON Stylus Scan FB TWAIN controls the Stylus Scan's scanner function.

EPSON Scanner Monitor

This software detects when the "Scan Button" is pressed on the Stylus Scan panel. The "Scan Button" automatically starts the software selected in the EPSON Scanner Monitor.

The included CD-ROM also contains the following software.

❑ Acrobat Reader

This software enables you to read the manual for EPSON SMART PANEL, or any other file that is in the Portable Document Format (PDF).

❑ FAXstf

Includes applications that support the Stylus Scan's fax features and other special operations.

Follow these steps to install your Stylus Scan software, and to connect the Stylus Scan to your Macintosh.



Caution:

Turn off all virus protection programs before you install your EPSON Stylus Scan software.

Note for iMac users:

If you are using Mac OS 8.1, you need to install iMac Update 1.0 before installing the Stylus Scan software. This update, along with complete update information, is available online from the Apple Web site. If you are using Mac OS 8.5 or later, you do not need to install iMac Update 1.0.

1. Turn on your Macintosh and insert the EPSON Stylus Scan 2500 Software for Macintosh CD-ROM in the CD-ROM drive. The EPSON window appears.
2. Double-click the Software Installer icon. The Select Language dialog box appears.

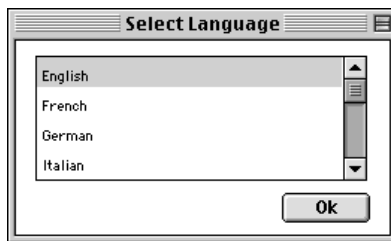

3. Select the language you want and click OK.

4. Click the Add Software button.



5. The EPSON Software Setup dialog box appears. Make sure there is a check mark next to EPSON SMART PANEL and EPSON Stylus Scan 2500 Drivers. Clear the check marks next to the names of any other software that you do not want to install.

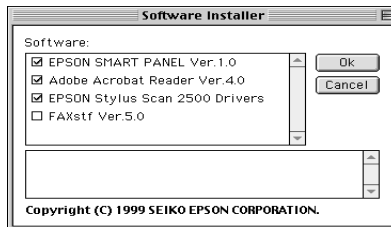

Note:

Please note that FAXstf cannot be installed at the same time as other applications. To use FAXstf, you must install it separately.

6. Click OK.
7. Follow the on-screen instructions to install EPSON SMART PANEL.
8. When installation is complete, the following dialog box appears.

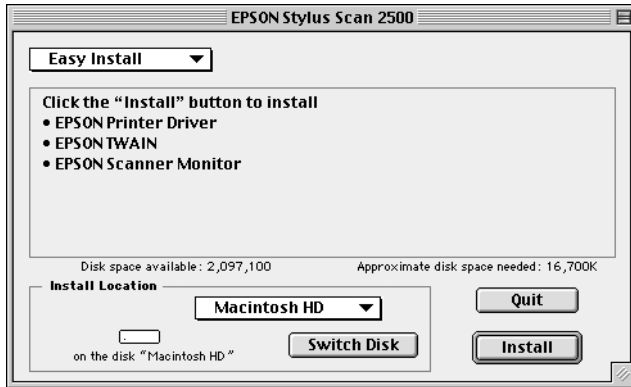

9. Click Install, then follow the on-screen instructions.
10. When the following dialog box appears, click Restart.

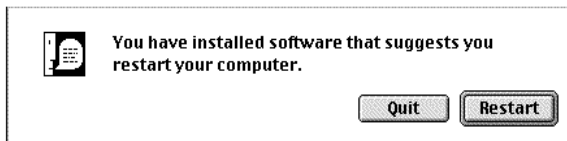

11. The EPSON Screen Calibration utility starts automatically. In the following window, move the slider to the right or left until the two shades of the gray horizontal stripes match.

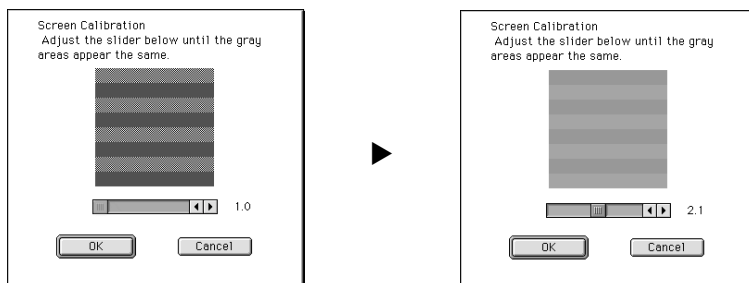

Note:

The gray stripes will not perfectly blend together; however, try to make the two tones match as closely as possible.

12. Click OK to register the calibration setting. The computer restarts automatically.
13. Turn on the Stylus Scan by pressing the  power button.
14. Plug the appropriate end of the USB cable into the USB port at the back of the Stylus Scan. (The end that attaches to the Stylus Scan has a different shape from the end that attaches to the computer.)

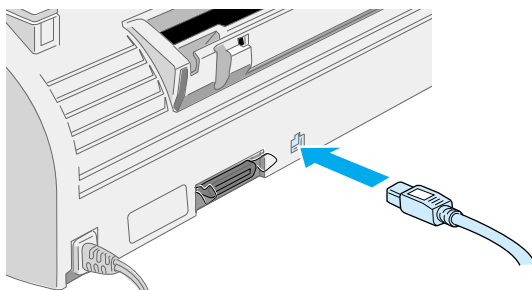

Note:

To connect the Stylus Scan to a USB port, use a standard shielded USB cable.

15. Connect the other end of the cable to the computer's USB port.

Note:

If you have more than one USB hub connected to your computer, connect the Stylus Scan to the hub that is connected directly to your computer. If the Stylus Scan does not work properly when connected to the hub, connect it directly to the computer's USB port.

Selecting your Stylus Scan in the Chooser

After you install the printer software on your Macintosh, you need to open the Chooser to select your Stylus Scan. You have to choose the Stylus Scan the first time you use it or whenever you want to switch to another printer. Your Macintosh always prints using the last printer selected.

1. Choose Chooser from the Apple menu. Click the SS2500 icon, and the port your Stylus Scan is connected to.

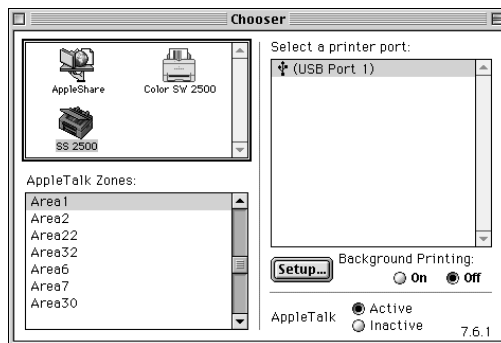

2. Click the Background Printing radio button to turn background printing on or off.

When background printing is on, you can use your Macintosh while it is preparing a document for printing. You must turn on background printing to use the EPSON Monitor3 utility to manage print jobs.

3. Close the Chooser.

Notice for USB users

If you connect several units of the same type, each unit is assigned a separate USB port number, such as USB port 1, USB port 2, and so on. Performing any of the following functions may cause the USB port numbers for the individual units to change.

- Restarting your Macintosh
- Turning the Stylus Scan off and on
- Detaching and reconnecting the USB cable

Please check the assigned USB port number in the Chooser after performing any of these functions.

Before turning on your USB hub (if necessary) and your Stylus Scan, turn on the Macintosh and wait until startup is completed.

When unplugging the USB cord, wait a few seconds before plugging it back in. Otherwise, the Macintosh may not recognize your Stylus Scan and you may be unable to print correctly.

Installing Ink Cartridges

Before installing the ink cartridges, note the following.



Warning:

The ink cartridges are self-contained units. Under ordinary use, ink will not leak from a cartridge. If ink does get on your hands, wash them thoroughly with soap and water. If ink gets into your eyes, flush them immediately with water. If discomfort or vision problems remain after a thorough flushing, see a doctor immediately.

Note:

Do not open the ink cartridge packages until just before you install them, or the ink may dry up.

Install the ink cartridges as follows.

1. Make sure the Stylus Scan is turned on.
2. Open the document cover and the maintenance cover. The scanner carriage moves out of the way automatically.

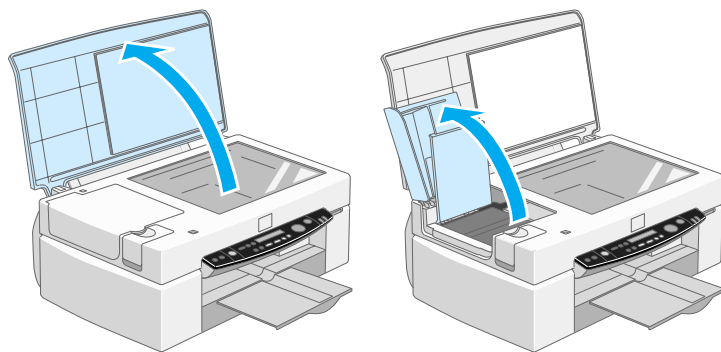

The print head moves to the left, to the ink cartridge installation position.



Caution:

Do not move the print head by hand. Doing so may damage the Stylus Scan.

3. Lift the ink cartridge clamp.

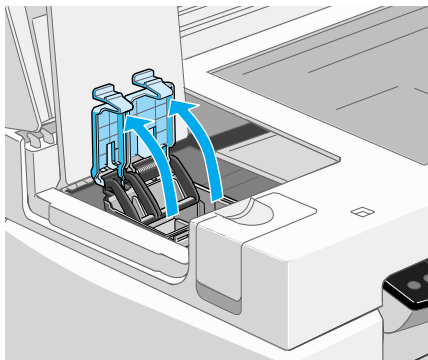

4. Open the ink cartridge packages. Remove the yellow tape seals from the cartridges.

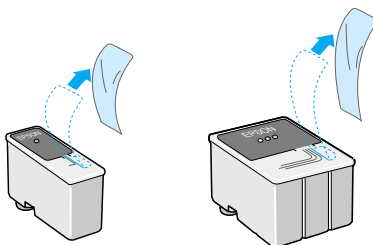



Caution:

- ❑ *Remove the yellow tape seals from the cartridges before installing them; otherwise the cartridges will be damaged and will become unusable.*
 - ❑ *Do not remove the blue portion of the tape seals from the cartridges; otherwise the cartridges will clog and become unusable.*
 - ❑ *Do not remove the tape seals from the bottom of the cartridges; otherwise, ink will leak.*
5. Place the cartridges gently into their holders with the labels face-up. The color ink cartridge goes on the right and the black goes on the left. Do not press down on the cartridges.

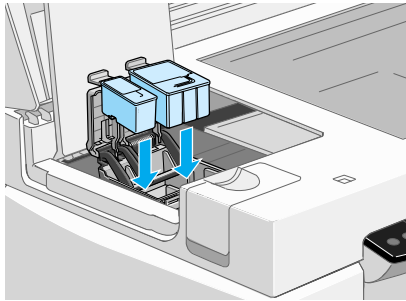

Note:

Install both ink cartridges. If either of the cartridges is not installed, the Stylus Scan will not work.

6. Press the ink cartridge clamps down until they lock in place.

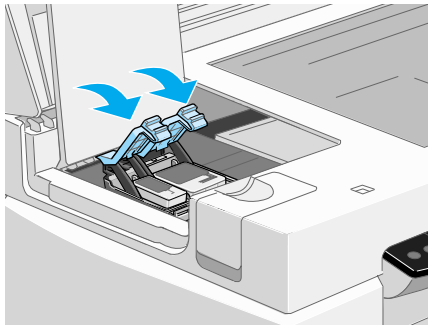

Caution:

Once you install the ink cartridges, do not open the clamps again until you need to replace the ink cartridges. Opening the clamps makes the cartridges unusable.

7. Close the maintenance and document covers. The scanner carriage will return to the home position.
8. Press the  cleaning button. The Stylus Scan print head will move, and the ink delivery system will begin charging ink.

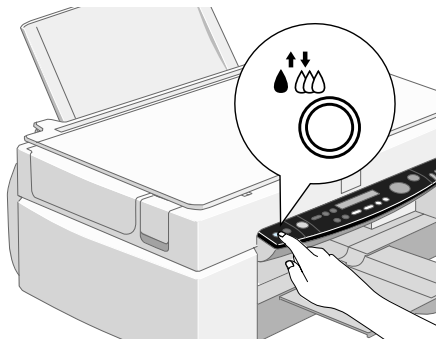

The ink charging process takes about one minute and a half to complete, during which time the Operate light flashes and the Stylus Scan produces a variety of mechanical sounds. These sounds are normal. When the ink delivery system has been charged, the print head returns to the home (far right) position and the Operate light stops flashing.



Caution:

Never turn off the Stylus Scan while the Operate light is flashing.

Checking the Stylus Scan

Before using your Stylus Scan, make sure it is working correctly by printing a nozzle check pattern. You may also need to clean the print head.

Loading paper

Follow these steps to load plain paper into the Stylus Scan.

1. Slide out the output tray. Next, slide the left edge guide so that the distance between the edge guides is slightly wider than the width of your paper. When loading long paper, pull out the paper support extension.

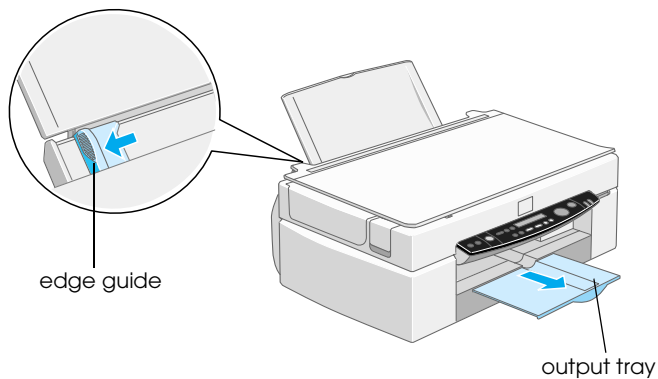

2. Fan a stack of paper; then tap it on a flat surface to even the edges.
3. Load the stack of paper with the printable side up and the right edge of the paper resting against the right side of the sheet feeder. Slide the left edge guide against the edge of the paper.

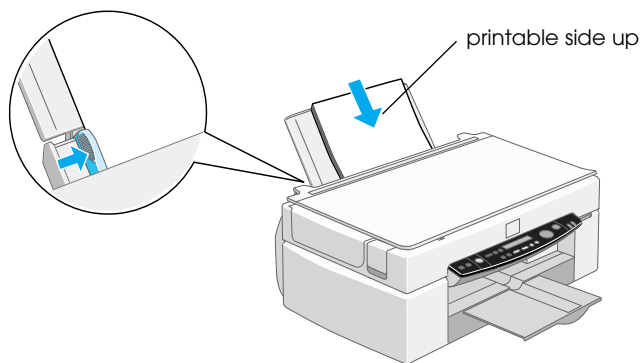



Note:

- ❑ Always load paper into the sheet feeder short edge first.
- ❑ Make sure the paper stack fits under the arrow mark inside the edge guide.

Printing a nozzle check pattern

Follow the on-screen instructions to check the print-head nozzles. If the on-screen instructions do not appear on your system, follow the instructions below.

Hold down the  load/eject button (① in the illustration below) and press the  power button (② in the illustration below) to turn on the Stylus Scan, then release both buttons. The Stylus Scan begins printing a nozzle check page.

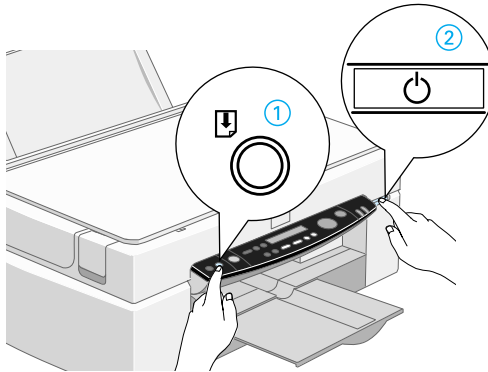

Here are sample printouts.

Good sample

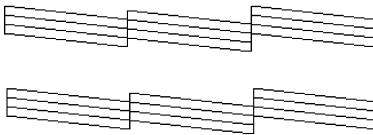

Print head needs to be cleaned

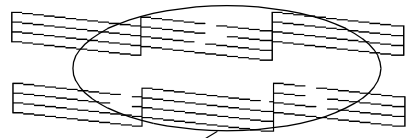

segments are missing

If the nozzle check page does not print satisfactorily (for example, if any segment of the printed lines is missing), then you should clean the print head as explained below. If the printout was satisfactory, you are ready to print your first page.

Cleaning the print head

1. Make sure that the Operate light is on and that an ink out message is not displayed on the LCD panel.
2. Hold down the  cleaning button for three seconds.

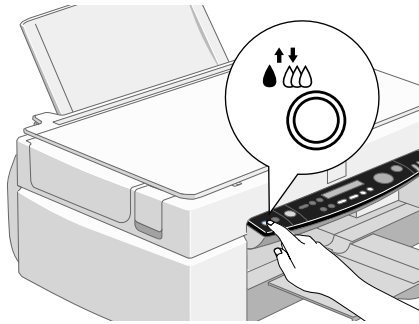

The Stylus Scan starts cleaning the print head and the Operate light begins flashing. Print head cleaning takes about one minute to complete.



Caution:

Never turn off the Stylus Scan while the Operate light is flashing. Doing so may damage the Stylus Scan.

3. When the Operate light stops flashing, print a few lines from a document to confirm that the head is clean and to reset the cleaning cycle.

If print quality hasn't improved after checking the nozzles and cleaning four or five times, contact your dealer.

After Setup

Changing the connection port (for Windows 98)

If you need to change the port from which the Stylus Scan is connected to your computer, you must first uninstall the Stylus Scan drivers currently installed in your PC.

Follow the steps below to uninstall the Stylus Scan drivers.

Uninstalling the USB driver

1. Click Start, point to Settings and Control Panel.
2. Double-click the Scanners and Cameras icon.

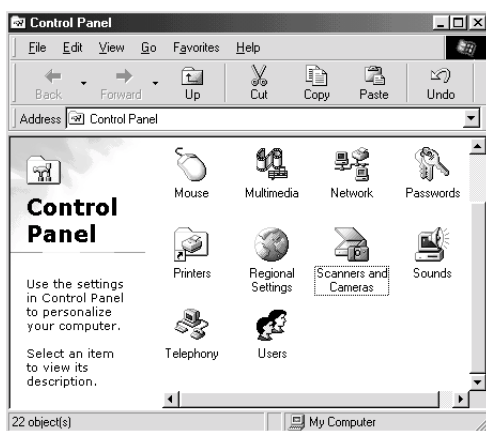

3. Select EPSON Stylus Scan 2500, then click Remove.
4. Click OK and close the dialog box.
5. Double-click the Add/Remove Programs icon.
6. Select EPSON Printer Software, then click Add/Remove.

7. Select EPSON Stylus Scan 2500, then click OK. Follow the on-screen instructions.
8. After uninstall is complete, select EPSON USB Printer Devices and click Add/Remove. Then follow the on-screen instructions. The computer restarts automatically.

To connect the Stylus Scan to your computer using the parallel port, see “Using the parallel port (for Windows 98 and 95)” on page 4.

Uninstalling the parallel driver

1. Click the Start button, point to Programs, select EPSON Stylus Scan, then click Uninstall EPSON Stylus Scan FB TWAIN.
2. Follow the on-screen instructions.
3. After uninstall is complete, click the Start button, point to Settings, then point to Control Panel.
4. Double-click the Add/Remove Programs icon, then select EPSON Printer Software and click Add/Remove.
5. Select EPSON Stylus Scan 2500, then click OK.
6. Follow the on-screen instructions.
7. After uninstalling, restart your computer.

To connect the Stylus Scan using the USB port, see “Using the USB port (for Windows 98 and Macintosh)” on page 4.

EPSON OVERSEAS MARKETING LOCATIONS

EPSON AMERICA, INC.

20770 Madrona Ave.
P.O. Box 2842
Torrance, CA 90509-2842
Phone: (800) 922-8911
Fax: (310) 782-5220

EPSON UK LTD.

Campus 100, Maylands Avenue,
Hemel Hempstead, Herts,
HP2 7TJ, U.K.
Phone: (+44) 01442 261144
Fax: (+44) 01442 227227

EPSON DEUTSCHLAND GmbH

Zülpicher Straße 6,
40549 Düsseldorf Germany
Phone: (0211) 56030
Fax: (0211) 5047787

EPSON FRANCE S.A.

68 bis, rue Marjolin
92300, Levallois-Perret, France
Phone: 33.1.40.87.37.37
Telex: 610657

EPSON AUSTRALIA PTY. LTD.

70 GIBBES STREET, CHATSWOOD 2067 NSW.
Phone: 2-9903-9000
Fax: 2-9903-9177

EPSON SINGAPORE PTE. LTD.

No. 1 Temasek Avenue #36-00
Millenia Tower, Singapore 039192
Phone: (065) 33 77 911
Fax: (065) 33 41 185

EPSON HONG KONG LTD.

Rooms 4706-10, 47/F,
China Resources Bldg.,
26 Harbour Road, Wanchai, Hong Kong
Phone: 2585-4300
Fax: 2827-7083

EPSON TAIWAN TECHNOLOGY & TRADING LTD.

10F, No. 287 Nanking E. Road, Sec. 3,
Taipei, Taiwan, R.O.C.
Phone: (02) 717-7360
Fax: (02) 712-9164

EPSON ITALIA S.p.A.

V.le F.lli Casiraghi 427
20099 Sesto S.Giovanni
MI, Italy
Phone: 2-262331
Fax: 2-2440750

EPSON IBERICA S.A.

Av. de Roma, 18-26
08290 Cerdanyola del Valles
Barcelona, Spain
Phone: 582. 15.00
Fax: 582. 15.55

SEIKO EPSON CORPORATION**(Hirooka Office)**

80 Harashinden, Hirooka
Shiojiri-shi, Nagano-ken
399-0785 Japan

EPSON PORTUGAL, S.A.

R. do Progresso, 471, 1° Perafita
4460 Matosinhos, Portugal
Phone: (02) 996 14 02
Fax: (02) 996 14 11

EPSON

All in One Product

EPSON STYLUS[™] SCAN 2500

Setup Guide

Printed in Japan
99.XX-X